

## Accessories: Mounting unit BES 18.0-KB-3

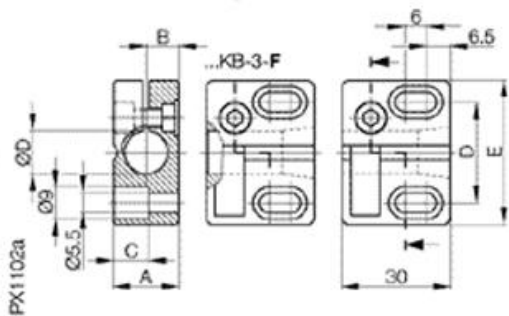

### Common Data

Version  
Usable with

Clamp  
clamp without positive stop for  
sensors M18 non-flush

	A	B	C	D	E	ØD
BES 12,0-KB-3	18	9	9,7	28	40	12
BES 18,0-KB-3	24	12	13,5	28	40	18
BES 12,0-KB-3-F	18	9	9,7	28	40	12
BES 18,0-KB-3-F	24	12	13,5	28	40	18
BES 30,0-KB-3-F	36	18	19,5	42	54	30

### Mechanical Data

Measurements WxHxD or Dia x D  
Material  
Mounting

40x30x24  
PA6 GK  
with 2 screws M5

Datasheet number::

Definitions see general catalog.

If not otherwise noted, ratings according to  
IEC 60947-5-2 (DIN EN60947-5-2)

Balluff GmbH  
Schurwaldstrasse 9  
73765 Neuhausen a.d.F.  
Phone (07158) 173-0 Fax (07158) 5010

Datenblatt by CD-ROM - 04/2007

**BALLUFF**  
sensors worldwide